

FX-QMW-G1-TU26H25W10

Accessories for Flexible LED strips

Cechy produktu

- Compatible with TEC Flex



Korzyści ze stosowania produktu

- Profile aluminiowe – wytrzymałe i odporne na korozję dzięki anodowanej powłoce

Karta katalogowa rodziny produktów

Dane techniczne

Opis produktu	Wymiary i waga				Dane logistyczne
	Wysokość	Szerokość	Długość	Masa produktu	Kod taryfy celnej
FX-QMW-G1 -TU26H25W10-300	24,0 mm	46,0 mm	3000 mm	929,00 g	760429909000
FX-QMW-G1 -EFGP-TU26H25W10	16,5 mm	24,5 mm	46,0 mm	1,70 g	392690979000
FX-QMW-G1 -ERGP-DIV1	6,0 mm	13,0 mm	24,0 mm	1,00 g	392690979000
FX-QMW-G1 -CFDB-300	4,0 mm	22,0 mm	3000 mm	96,00 g	391690509000
FX-QMW-G1 -CRD-300	20,0 mm	24,0 mm	3000 mm	282,00 g	391690509000
FX-QMW-G1 -CFTP-300	2,0 mm	22,0 mm	3000 mm	15,90 g	392690979000
FX-QMW-G1 -SRME-DIV1	11,0 mm	40,0 mm	50,0 mm	3,20 g	732090909000

Opis produktu	Environmental information Information according Art. 33 of EU Regulation (EC) 1907/2006 (REACH)			
	Date of Declaration	Primary Article Identifier	Candidate List Substance 1	Declaration No. in SCIP database
FX-QMW-G1 -TU26H25W10-300	30-08-2022	4052899448773	No declarable substances contained	No declarable substances contained
FX-QMW-G1 -EFGP-TU26H25W10	30-08-2022	4052899450134		In work
FX-QMW-G1 -ERGP-DIV1	11-02-2022	4052899999824	No declarable substances contained	No declarable substances contained
FX-QMW-G1 -CFDB-300	30-08-2022	4052899447806	No declarable substances contained	No declarable substances contained
FX-QMW-G1 -CRD-300	30-08-2022	4052899447035	No declarable substances contained	No declarable substances contained
FX-QMW-G1 -CFTP-300	02-02-2022	4052899999787	No declarable substances contained	No declarable substances contained
FX-QMW-G1 -SRME-DIV1	30-08-2022	4052899446786	No declarable substances contained	No declarable substances contained

Karta katalogowa rodziny produktów

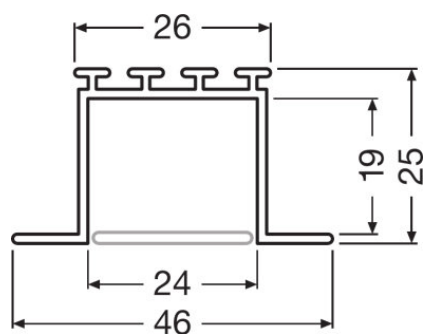

728412_FX-QMW-G1_TU26H25W10-300

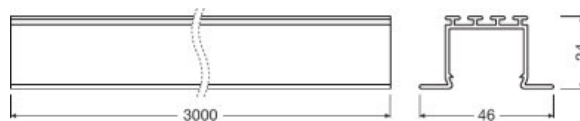

728991_FX-QMW-G1-TU26H25W10-300

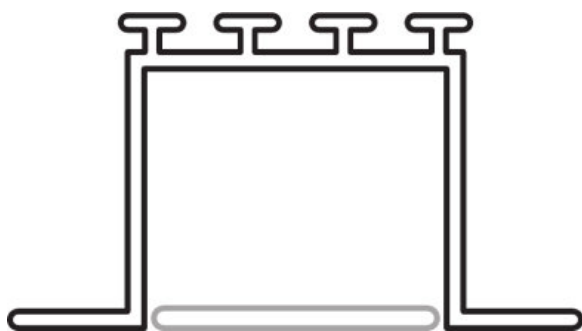

728444_FX-QMW-G1_TU26H25W10-300

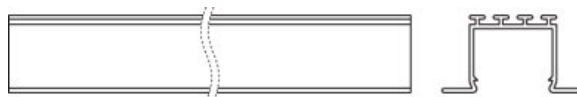

729058_FX-QMW-G1-TU26H25W10-300

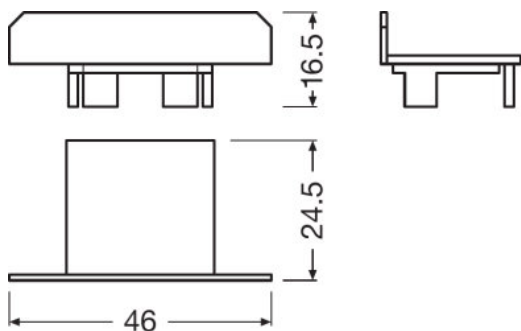

729013_FX-QMW-G1-EFGP-TU26H25W10

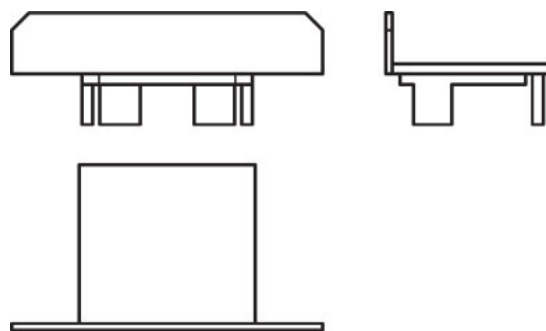

729081_FX-QMW-G1-EFGP-TU26H25W10

Karta katalogowa rodziny produktów

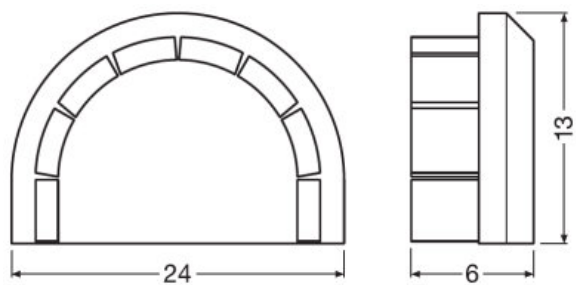

FX-QMW-G1-ERGP-DIV1



729112_FX-QMW-G1-CFDB-300



729089_FX-QMW-G1-CFDB-300



729000_FX-QMW-G1-CRD-300



729067_FX-QMW-G1-CRD-300



FX-QMW-G1-CFTP-300

Karta katalogowa rodziny produktów

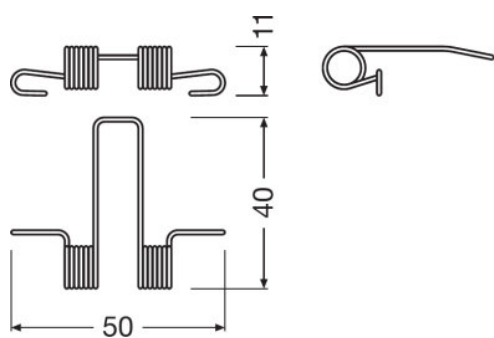

729018_FX-QMW-G1-SRME-DIV1

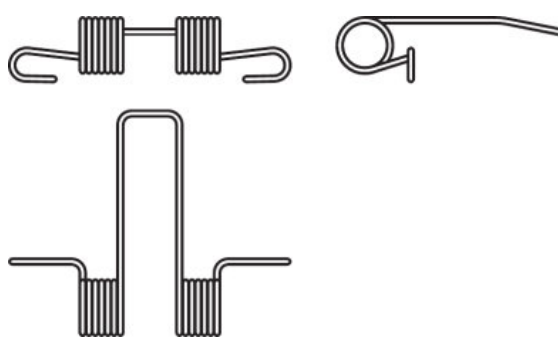

729086_FX-QMW-G1-SRME-DIV1







Wskazówki dotyczące zastosowania

Więcej szczegółowych informacji dotyczących grafik i zastosowania znajduje się w karcie katalogowej produktu

Sprzedaż i pomoc techniczna

Sprzedaż i pomoc techniczna www.osram.com

Pobierz dane

Plik	
	Product Datasheet Specification Sheet Wide Track FX-QMW-G1-TU26H25W10-300
	Broszury Light is freedom of design (EN)
	Dane CAD CAD file wide profile TU26H25W10
	Product Datasheet Specification Sheet Wide Track FX-QMW-G1-TU26H25W2-300 (EN)
	Product Datasheet Specification Sheet Wide Track FX-QMW-G1-TU26H25-300 (EN)
	Product Datasheet Specification Sheet_Wide Track FX-QMW-G1-TK30D46H27-300 (EN)
	Product Datasheet Specification Sheet_Wide Track FX-QMW-G1-TU26H8-300 (EN)

Karta katalogowa rodziny produktów

Dane logistyczne

Kod produktu	Opis produktu	Opakowanie (liczba produktów / opakowanie)	Wymiary (długość x szerokość x wysokość)	Objętość	Waga brutto
4052899448773	FX-QMW-G1 - TU26H25W10-300	Karton wysylkowy 4	3020 mm x 150 mm x 150 mm	67.95 dm ³	5116.00 g
4052899450134	FX-QMW-G1 -EFGP-TU26H25W10	Karton wysylkowy 400	250 mm x 245 mm x 180 mm	11.03 dm ³	1000.00 g
4052899999824	FX-QMW-G1 -ERGP-DIV1	Karton wysylkowy 400	175 mm x 145 mm x 110 mm	2.79 dm ³	506.00 g
4052899447806	FX-QMW-G1 -CFDB-300	Karton wysylkowy 40	3020 mm x 80 mm x 30 mm	7.25 dm ³	4380.00 g
4052899447035	FX-QMW-G1 -CRD-300	Karton wysylkowy 40	3020 mm x 200 mm x 200 mm	120.80 dm ³	13300.00 g
4052899999787	FX-QMW-G1 -CFTP-300	Karton wysylkowy 40	3020 mm x 80 mm x 30 mm	7.25 dm ³	1176.00 g
4052899446786	FX-QMW-G1 -SRME-DIV1	Karton wysylkowy 400	250 mm x 245 mm x 180 mm	11.03 dm ³	1600.00 g

Wymieniony kod produktu oznacza najmniejszą ilość produktu, jaka może być zamówiona. Jednostka transportowa może zawierać jedną sztukę lub więcej. Składając zamówienie prosimy o zamawianie ilości odpowiadających jednej lub wielokrotności jednostki transportowej.

Akcesoria opcjonalne

Opis produktu	Nazwa akcesorium	Kod akcesorium
FX-QMW-G1 -TU26H25W10-300	FX-QMW-G1 -SRME-DIV1	▶ 4052899446786
FX-QMW-G1 -TU26H25W10-300	FX-QMW-G1 -CFDB-300	▶ 4052899447806
FX-QMW-G1 -TU26H25W10-300	FX-QMW-G1 -CRD-300	▶ 4052899447035
FX-QMW-G1 -TU26H25W10-300	FX-QMW-G1 -EFGP-TU26H25W10	▶ 4052899450134
FX-QMW-G1 -TU26H25W10-300	FX-QMW-G1 -CFTP-300	▶ 4052899999787
FX-QMW-G1 -TU26H25W10-300	FX-QMW-G1 -ERGP-DIV1	▶ 4052899999824

Oświadczenie

Zastrzega się możliwość zmian bez uprzedzenia. Błędy i ominięcia są możliwe. Należy zawsze upewnić się czy korzystasz z najnowszej wersji katalogu.